

P
R
N
D
3
2
1

FRONTZONE[®]
By Komet
USER'S MANUAL
PARKING SENSOR SYSTEM

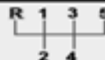

Please read this manual thoroughly before installation and use

CONTENT

INTRODUCTION	1	INSTALLATION TOOLS	8
MODEL NUMBER	1	WHERE TO INSTALL	9
FEATURES	1	INSTALLATION PROCEDURE	9
TECHNICAL DATA	2	SENSOR INSTALLATION	10
PRODUCT COMPOSITION	3	POWERING UP	12
HOW TO USE		PRECAUTIONS	13
SYSTEM STARTUP	3	TEST THE SYSTEM	
DIAGNOSTICS	3	TEST SUBJECTS	13
WARNING MODE	4	TEST METHODS	13
WARNING UNIT	6	DISCLAIMER	15
ABOUT DETECTION	6	TROUBLESHOOTING	15
PRECAUTIONS	8	WARRANTY CARD	18
INSTALLATION			

● INTRODUCTION

The FrontZone™ is a front parking system that provides a visual and audible alarm when close to large objects to aid the driver while parking.

- Read this manual thoroughly before installation and operation of the system. Please pay attention to all of the precautions and instructions listed in this manual.
- Installation by trained professionals is recommended.
- This manual describes the functions, installation, use and precautions of the parking system.
- Designs and specifications are subject to change without prior notice and the diagrams or figures in this manual may differ slightly in appearance from the actual product.
- This device is only a parking aid and should never be solely relied upon for operation. The use of this system should never replace normal operational and safety precautions needed for operating a vehicle. Always use caution during any vehicle operation.

➤ Model number

The model number and system description/features are listed on the box.

➤ Features

- ◆ High sensitivity: Able to quickly detect large obstacles (car, wall, pole, etc.) up to 2.5M (98") in front of the vehicle.
- ◆ Automatic operation: OFF above 10mph (16km/h), ON below 6mph (km/h).
- ◆ Min. display distance: 28cm (approx. 11").
- ◆ Parking curb detection capable.
- ◆ Wide detection angle with minimal blind area.
- ◆ Adjustable alarm volume: high, low and off.
- ◆ Diagnostic functions monitor and alert you of inoperable sensors.
- ◆ Attractive and ergonomic display unit.
- ◆ Small, unobtrusive sensor design and shape.
- ◆ Reliable performance, design and use of high-quality components ensure consistent operation.

Diagram-1: TECHNICAL DATA OF PARKING SYSTEM

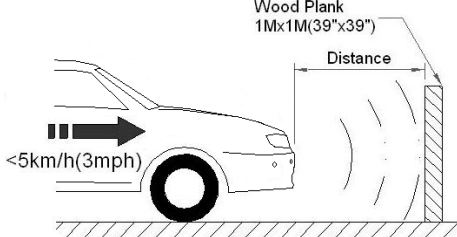
NO	ITEM	LED	REMARKS
1	Working Voltage (VDC)	9 ~ 16 (Rated Voltage: 12)	1. Display distance is the detected distance from sensor to obstacle during operation at 25C. 2. The display distance results from detecting a square wood plank of 1mx1m (39"x39").
2	Rated Current (max.)	200mA	
3	Display Distance: m (in.)	0.28 (11")~2.5 (98")	
4	Blind Area: m (in.) at 25C	<0.28 (11")	
5	Detection Tolerance: m (in.) at 25C	±0.03 (1")	
6	Warning Mode	Sound	<input checked="" type="checkbox"/>
		Distance	<input checked="" type="checkbox"/>
		Zone	<input checked="" type="checkbox"/>
		Direction	<input checked="" type="checkbox"/>
		Video	-
7	Display Type	LED	
8	Sound Frequency	2.4kHz	
9	Working Temperature(C)	-30~+75	
10	Storage Temperature(C)	-40~+90	
11	CAN BUS Interface Type	OBDII	

● **PRODUCT COMPOSITION**

The system consists of 3 basic components (see Figure 1):

- ➔ **Electronic Control Unit (ECU)**
- ➔ **Ultrasonic Sensors**
- ➔ **Warning Display**

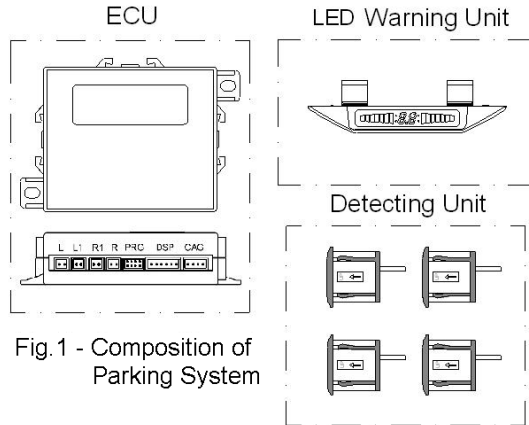

Fig. 1 - Composition of Parking System

When the vehicle ignition is turned on, the display warns drivers of obstacles in different ways: sound, display of warning zones, distance to and direction of obstacles.

Note: The display has a high-low-off switch for audible warning volume control. The display may be mounted on the visor (upside down) or on the dash (right side up). The display has a switch to rotate the display during installation.

● **HOW TO USE**

➔ **System Startup**

➤ Parking System

◆ The system is fully automatic. It is active when the vehicle ignition is on. It is inactive when the speed is above 10mph (16km/h) and reactivates when the speed is below 6mph (10km/h).

◆ At system power-up (Vehicle ignition on), you will hear a short half-second 'beep'.

➔ **Diagnostics**

◆ After the system is turned on, the FrontZone will go

through a self diagnostic mode.

◆ If a sensor malfunction is detected, the display will warn you of a fault. The system will still operate, but **may not function normally**. (See troubleshooting section for explanation of diagnostics function.)

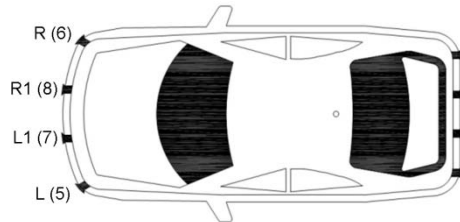

Fig.2 - Definition of Sensor's Serial Numbers

Note: Sensors must be installed in order of serial number. If not, the diagnostic function may reference the wrong sensor. See Figure 2.

➔ **Warning Mode**

See Figure 3 for the three detection zones.

☞ Audible Warning: System beeps when an

obstacle appears within the Warning zones, shown in Diagram 2.

Fig.3-Warning Zones

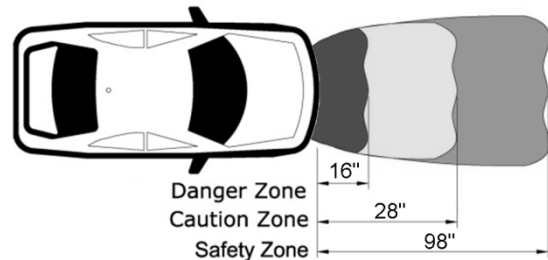

Diagram-2: AUDIBLE WARNING MODE FOR FRONT DETECTION

WARNING ZONE	DISTANCE (D)	AUDIBLE WARNING MODE
Danger Zone M(in.)	$00" < D < 11"$	Beep(Bi)
	$11" \leq D < 12"$	Bi.Bi.Bi
	$12" \leq D \leq 16"$	Bi. .Bi. .Bi
Caution Zone M(in.)	$16" < D \leq 20"$	Bi...Bi...Bi
	$20" < D \leq 24"$	Bi....Bi....Bi
	$24" < D \leq 28"$	Bi.....Bi.....Bi
Safety Zone M(in.)	$28" < D \leq 32"$	Bi.....Bi.....Bi
	$32" < D \leq 38"$	-
	$38" < D \leq 98"$	-
Outside	$98" < D$	-

Note: When there is more than one obstacle, the system indicates the distance and direction of the closest one. If an obstacle remains at a fixed distance for over 3 seconds, the system stops the audible warning

but still shows distance.

Diagram-3: INDICATION OF DISTANCE AND ZONE FOR FRONT DETECTION

WARNING ZONE	DISTANCE(D) M(in.)	DISTANCE DISPLAY
Blind Zone	$D < 0.28(11")$	-P- (STOP)
Danger Zone	$0.28(11") \leq D \leq 0.4(16")$	(Inches)
Caution Zone	$0.4(16") < D \leq .7(28")$	(Inches)
Safety Zone	$.7(28") < D \leq 2.5(98")$	(Inches)
Outside	$98" < D$	-

- The display shows distance only when an obstacle is detected within the range of 2.5m (98") from the sensor.
- When an obstacle enters the Danger Zone, be prepared to brake immediately. When the obstacle enters the Blind Zone ("P-" will appear in the display), you should apply

your brake immediately.

➔ **Warning Unit**

This unit warns you with a tricolor LED display with a built-in buzzer, enabling you to know the warning zone, direction (left, right) and distance to the obstacle.

See Fig.4 and Fig. 5

- Indication of direction - The left and right wave bands show drivers if the obstacle is to the left or right in front of the vehicle.
- Indication of zone - The wave bands are green, yellow and red. Color changes as the vehicle moves closer to the obstacle, telling drivers the warning zone where the obstacle is located.

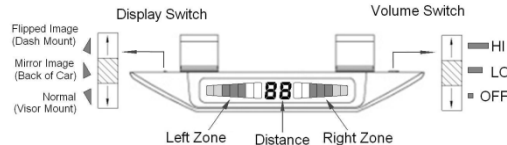

Fig.4 - LED Display for Parking System

➔ **About detection**

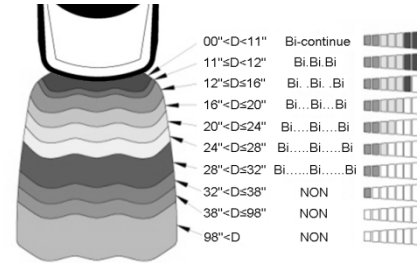
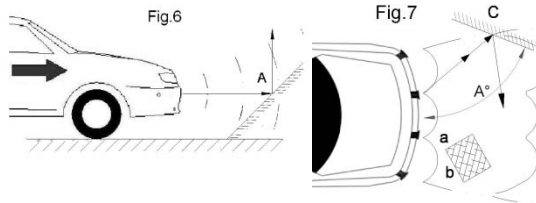

Fig.5-Warning Mode of PS-LE Series

Obstacle detection may vary due to object size, shape, density and environmental conditions. It is recommended to thoroughly check the system sensitivity before use.

➔ An unusual reflection angle of obstacles may cause an incorrect or unusual detection warning.

Refer to Fig.6 below: Point A may not be detected due to unsatisfactory reflection angle.



In Fig.7, detection may be variable due to object size, height and density. Angled surfaces may give false distance measurements. Various surface angles may be detected at varying distances on the display.

➤ Low obstacle standing before a tall one

As shown in Fig.8, although Obstacle T_{a-b} is lower than the sensors, Part T_b will be detected and warned first.

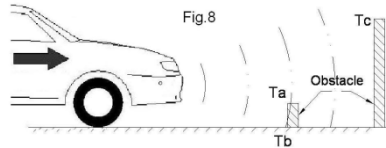

As you approach these obstacles, the warnings may vary in intensity.

➤ Unusual condition of obstacle

Due to varying height, size, clothing type (absorption of signal), etc., **A PERSON MAY NOT BE DETECTED**. This device is only a parking aid and should never be solely relied upon for safely parking a vehicle.

Always use caution during any vehicle operation.

➤ Obstacles outside the detecting range

In Fig.9, Surface B will be detected, while Surface A may never be detected.

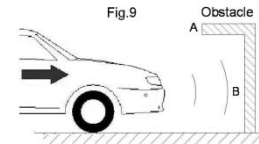

➤ Unusual road surface condition

When road surfaces are rough, the system may output a warning signal. See Fig.10.

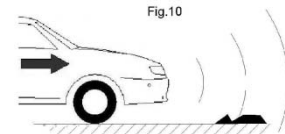

➔ **Obstacles in blind zone**

The blind zone covers a range of zero to 28cm (11") in front of the vehicle. Obstacles in the blind zone will never be detected. Therefore, it is normal if the warning unit provides incorrect detection results. See Fig.11.

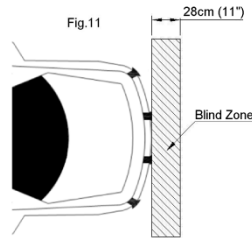

➔ **Precaution**

- 🔔 When this system is working, it will automatically turn to standby mode if the vehicle speed is above 16km/h (10mph). The system will turn to working mode if the vehicle speed is below 10km/h (6mph).
- 🔔 Keep sensors clean. Remove dirt, ice or snow for proper operation.
- 🔔 Make sure that sensors are mounted securely in the

correct position.

- 🔔 When sensors are found defective, they should be replaced immediately.
- 🔔 After installation, testing should be conducted to verify proper operation before use.

● **INSTALLATION**

It is recommended this system be installed by a trained installation professional.

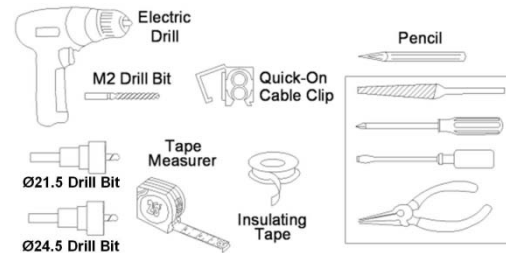

Fig. 12 - List of Installation Tools

➔ **Installation Tools**

The tools listed in Fig.12 are required for installation.

The kit includes two drill bits, electrical connectors, double-sided adhesive tape. In addition a file, flat head screwdriver, Phillips head screwdriver and a pair of pliers will be required.

➔ **Where to Install**

Fig.13 gives a general layout showing where to install the components of the parking system.

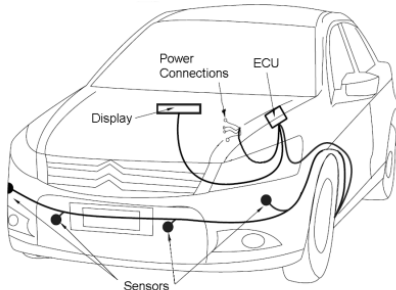
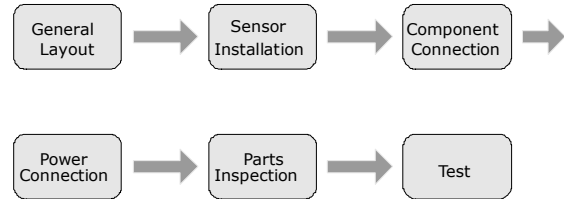

Fig.13 - Installation Diagram

➔ **Installation Procedure**



➤ **General layout**

Determine where to install the ECU and warning unit according to the layout of your vehicle. Make sure the power cable of the ECU can be easily connected.

➤ **Sensor installation**

For details, refer to "Tips on Sensor Installation" on page 10.

➤ **Component Connection**

◆ See Fig.14 for the connection between components of the parking system.

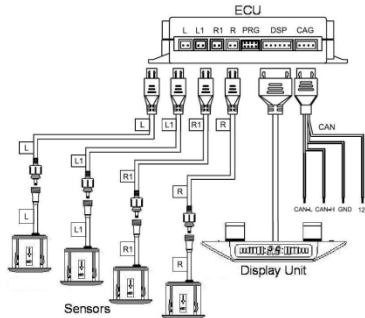

Fig.14 - Connection between each unit of Reverse Parking System

- Control unit
 - ◆ The parking system has 1 ECU that should be installed near the power, ground and CAN connections in the front of the vehicle.
- Warning unit
 - ◆ Install the LED display on the visor using supplied clamps, or, a flat spot on the dashboard using supplied adhesive

strip.

➤ Powering up

For details, refer to "Powering up" on page 12.

➤ Test

For details, refer to "Test the System" on page 13.

Note: Sensors and harness connectors are serialized and must be connected in position and order as shown in Figure 2; otherwise the display will indicate improper location of object.

➤ **Tips on Sensor Installation**

➤ Width of different vehicle models varies; it is very important to choose the correct locations to install sensors.

◆ Sensors need to be installed with the "Up" mark facing up as shown in Fig. 15.

◆ Sensor must be fully inserted and fit flush to bumper face.

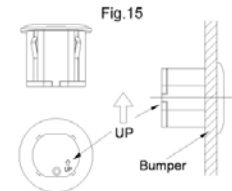

- ◆ Area behind sensor must be open and not contact sensor body (bumper, mounting brackets, foam...etc.).
- ◆ The face of the sensor should be perpendicular to the ground. If the bumper surface is angled, use the supplied angled bezels to compensate.

Note: To use angled bezels, first, carefully remove bezel from sensor. Snap correct angled bezel on sensor with bezel angle in proper orientation.

- ◆ Horizontal and vertical positioning

The horizontal distance between sensors is decided by the width of vehicle "L". For a wider detection area, locate side sensors closer to the lateral sides of the vehicle.

- For 4-sensor installations see Fig.16.

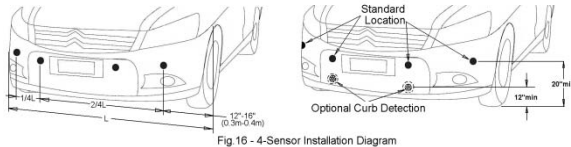

- For 4-sensor installations with optional curb detection, mount two center sensors at min height of 12". See Fig. 16.

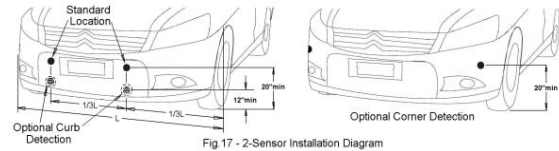

- For 2-sensor installations see Fig. 17
- For corner detection installations, see Fig. 17.
- ◆ Installation steps
 - Mark the positions of each sensor on bumper using supplied sensor mounting template and a marker to ensure proper location.
 - Drill holes using the included hole saw. (An M2/.079" drill bit can be used to drill pilot holes to aid in this process.)
 - Remove the burrs from the hole edge with a file.

- Insert the sensor cables into the holes made in bumper according to serial number. Refer to Figure 2

IMPORTANT

- Use correct hole saw. Sensors may not function properly with holes that are too small or too large in diameter.
- Plastic bumpers require the 21.5mm hole saw. Plastic bumpers do not require the rubber sleeves included in kit.
- Metal bumpers require the 24.5mm drill. Metal bumpers require rubber sleeves installed before installing sensors. (Note: The rubber sleeves must be oriented with "UP" notation mounted up).
- Sensors can be re-painted to match the color of your vehicle. Note: The painting layer must be symmetrical and less than 0.1mm (.004 in.) thick.

➔ **Powering Up**

- Power connections of the parking system

The control module gets power from the ignition circuit of the vehicle. Refer to Fig.18.

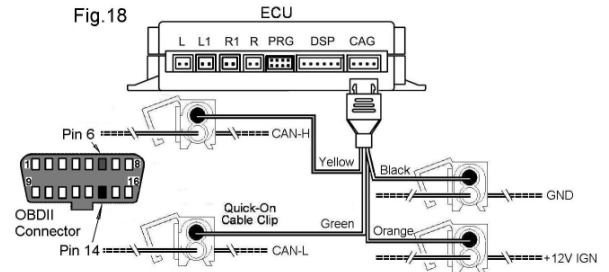

- ◆ It is recommended to solder all connections. If it is not possible to solder the connections, use the supplied electrical connectors.

- Press the metal part tightly to ensure cables are well connected. See Fig.19.

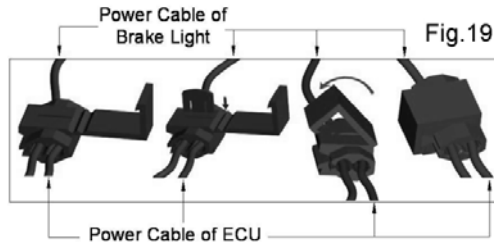

➤ Power connection steps :

- ◆ Securely connect the power cable of ECU to +12V wire of the ignition circuit;
- ◆ Securely connect the ground cable of ECU to a vehicle ground point.

➤ CAN connection steps (Refer to Fig 18 and 19)

- ◆ Securely connect the Green CAN-L wire to Pin 14 of the OBDII connector;
- ◆ Securely connect the Yellow CAN-H wire to the Pin 6 of the OBDII connector.

➤ **Precautions**

- ◆ Vehicle engine must be off when installing the system.
- ◆ The ECU must not be installed near any potential sources of interference, e.g. exhaust pipe, other cables or groups of cables.
- ◆ Detection results may be affected if sensors are installed in steel bumpers without rubber sleeves.
- ◆ Ultrasonic and electromagnetic waves from other sources near the system may affect detection results.

● **TEST THE SYSTEM**

➤ **Test Subjects**

➤ Audible warning

Refer to Fig 3 and 5

➤ Distance, direction and warning zones

Refer to Fig 4 and 5

➤ Turning on parking system

Once vehicle ignition is turned on, system is automatically activated; when vehicle reaches speed above 10mph

(16kmh), system goes into standby mode. Once vehicle speed goes below 6mph (10km/h), system goes into working mode.

➔ **Test Methods**

➔ Test tools

Conduct tests by using obstacles in front of the vehicle.

- ◆ Prepare a PVC tube of Ø75mmX1000mm(Ø3”X39”L) for short distance test.
- ◆ Prepare a wood plank of 500X500X10mm (20”X20”X4”) for long distance test: > 1.2M (47”)

➔ Tests of detection

- ◆ Turn the vehicle key to “ON” position, don’t start the vehicle engine.
- ◆ Move the 2 obstacles forward and backward 20~200cm(8”-79”) in front of vehicle. System should beep and/or visually show the warning zones, distance to and direction of the obstacles.
- ◆ Check the sensors one by one. Refer to Fig.20 & 21.

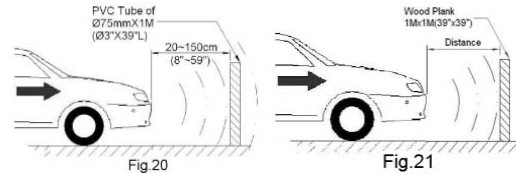

- ◆ Test for optional curb detection mounting.

Refer to Fig.22.

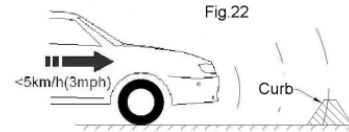

● **DISCLAIMER**

- 🔔 The system is designed and intended as a warning aid for parking only.
- 🔔 The supplier of this product accepts no responsibility for any accidents and/or damage caused during the use of this system.

 Detection results may be affected by environmental conditions: i.e. rain, fog, snow, extreme temperature. Due to obstacle variability and road conditions, warning levels may vary or obstacles may be undetected.

 Ultrasonic and electromagnetic waves from other sources near the system may affect detection results.

● **TROUBLESHOOTING**

➤ **Fault-Warning mode** The following chart shows what will be displayed during a diagnostic-fault:

**Diagram 4: AUDIBLE & VISUAL WARNING MODE
OF DIAGNOSTICS**

Serial No. of Defective Sensors	Audible Warning	Display
5	Bi	E5
6	Bi.Bi	E6
7	Bi.Bi.Bi	E7
8	Bi.Bi.Bi.Bi	E8
Note: Multiple sensor faults may be displayed in succession		

◆ Audible warning of diagnostics

If a sensor is found defective during diagnostics, the system will tell you its serial number by beeping per Diagram 4. If all sensors are defective, the system will beep a solid tone for 1.5 seconds.

Ex. 1: in case sensor No. 7 is abnormal

When powered on, system beeps once for 0.5 second (signal for diagnostics), then rapidly beeps 3 times (signal of sensor No. 7 that is abnormal). This alert will continue each time the system is started until the problem with sensor No. 7 is resolved.

Ex. 2: in case both sensors No. 2 and 4 are abnormal

When powered on, the system beeps once for 0.5 second, and then rapidly beeps 2 times, you should power off the system and solve the problem of sensor No. 6. When you re-start the system, after the beep of 0.5 second, the system will beep rapidly 4 times, indicating a problem with sensor No. 8.

◆ Visual warning of diagnostics

· When diagnostics are over, the display shows you the

serial number of abnormal sensor. Refer to Diagram 4.

- Display mode

If a sensor is found abnormal, "EX" will be displayed for less than 3 seconds, "X" is the serial number (5 through 8) of the abnormal sensor.

Ex 1: If "E5" is displayed, it tells you sensor No. 5 is operating abnormally.

Ex 2: If neither sensor No. 2 nor No. 4 works, "E6" and "E8" will appear in the display successively.

If none of the sensors works, "EE" will be displayed and the system will beep continuously for 1.5 seconds.

If the ECU is disconnected or getting incorrect information from the CAN-BUS interface, "E0" will be displayed and the system will sound 5 beeps consecutively.

➤ The following chart provides you with solutions to a few simple problems.

PROBLEM	REASON	SOLUTION
System doesn't react when ignition is ON.	1. System is not powered up or wrong connection of power cable. 2. Invalid connection between display and ECU.	1. Check the power and ground connections. 2. Check the connection between display and ECU.
After activation, system continuously beeps for 3 seconds.	1. Invalid connection between sensors and ECU. 2. All sensors are defective.	1. Check the connection between sensors and ECU. 2. Replace the defective sensors.
The display distance remains the same while distance to obstacle varies.	1. Incorrect installation direction of sensors. 2. Incorrect installation angle of sensors.	1. Follow the "UP" mark and re-install sensors. 2. Adjust the position of detecting angle to avoid downward detection.
In case no obstacle is found in the detection range, display always shows "-P-" and system beeps.	1. Sensor(s) is loose. 2. System is detecting vehicle itself or its spare parts, for example the spare tire.	1. Ensure sensor is fixed tightly in bumper. 2. Adjust the position of sensors and the detection angle.
Wrong indication of direction.	The serial number of the sensor plug is different from that of the ECU socket.	Re-connect sensor plugs to ECU sockets by matching serial numbers. (See Fig. 2, page 4)
The display refuses to work when vehicle's other lights are on.	Wrong connection of ECU's ground cable.	Correctly reconnect the ground cable of ECU.

36,000 MILE/36 MONTH LIMITED WARRANTY

Rostra Precision Controls, Inc. (the Company) warrants to the original retail purchaser of this Product that should this product or any part thereof, under normal use and conditions, be proven defective material or workmanship within 36 months of the original purchase, such defect(s) will be repaired or replaced (at the Company's option) without charge for the parts.

To obtain repair or replacement within the terms of this Warranty, the product is to be delivered with proof of warranty coverage (e.g. dated bill of sale), specification of defect(s), transportation prepaid, to the installing dealer and/or retailer.

This Warranty does not cover costs incurred for removal or reinstallation of the product, or damage to vehicle electrical systems.

This Warranty does not apply to any product or part thereof which in the opinion of the Company has been damaged through alteration, improper installation, mishandling, misuse, neglect, or accident.

This Warranty is in lieu of all other express warranties or liabilities. ANY IMPLIED WARRANTIES, INCLUDING ANY IMPLIED WARRANTY OF MERCHANTABILITY, SHALL BE LIMITED TO THE DURATION OF THIS WRITTEN WARRANTY. ANY ACTION FOR BREACH OF ANY WARRANTY HEREUNDER INCLUDING ANY IMPLIED WARRANTY OF MERCHANTABILITY MUST BE BROUGHT WITHIN A PERIOD OF 42 MONTHS FROM DATE OF ORIGINAL PURCHASE. IN NO CASE SHALL THE COMPANY BE LIABLE FOR ANY CONSEQUENTIAL OR INCIDENTAL DAMAGES FOR BREACH OF THIS OR ANY OTHER WARRANTY, EXPRESS OR IMPLIED, WHATSOEVER. No person or representative is authorized to assume for the Company any liability other than expressed herein in connection with the sale of this product.

THE EXTENT OF THE COMPANY'S LIABILITY UNDER THIS WARRANTY IS LIMITED TO THE REPAIR OR REPLACEMENT PROVIDED ABOVE AND, IN NO EVENT, SHALL THE COMPANY'S LIABILITY EXCEED THE PURCHASE PRICE PAID BY THE PURCHASER FOR THE PRODUCT.

Some states do not allow limitations on how long an implied warranty lasts or the exclusion or limitation of incidental or consequential damage so the above limitations or exclusions may not apply to you. This Warranty gives you specific legal rights and you may also have other rights which vary from state to state.

OWNER'S WARRANTY RECORD

To be completed by installer and retained by customer

Customer's Name _____ Part # _____

Dealer Name _____

Dealer Address _____

City _____ State _____ Zip _____

Phone # _____ Fax # _____

Email _____

Date Purchased _____ Mileage _____ Date Installed _____

Make _____ Model _____ Year _____

Vin# _____

Customer Complaint _____

Description of Defect/Repair _____

Notice to Installer: Contact your distributor for technical assistance or return authorization. **THIS CARD MUST BE COMPLETE AND ACCOMPANY THE RETURNED PRODUCT.** Any alteration to product, damage caused by installation or use with any product not manufactured or recommended by Rostra Precision Controls, Inc. voids the warranty & parts will be returned.